



AVORA DOORS

American Style Window

Timeless style meets everyday performance with Avora Doors American Style Windows—featuring clean design, smooth operation, and lasting durability for any space.



+1 512-522-2284



info@avoradoors.com



www.AvoraDoors.com



Texas Facility 1309 Ave H Grand
Prairie, TX 75050

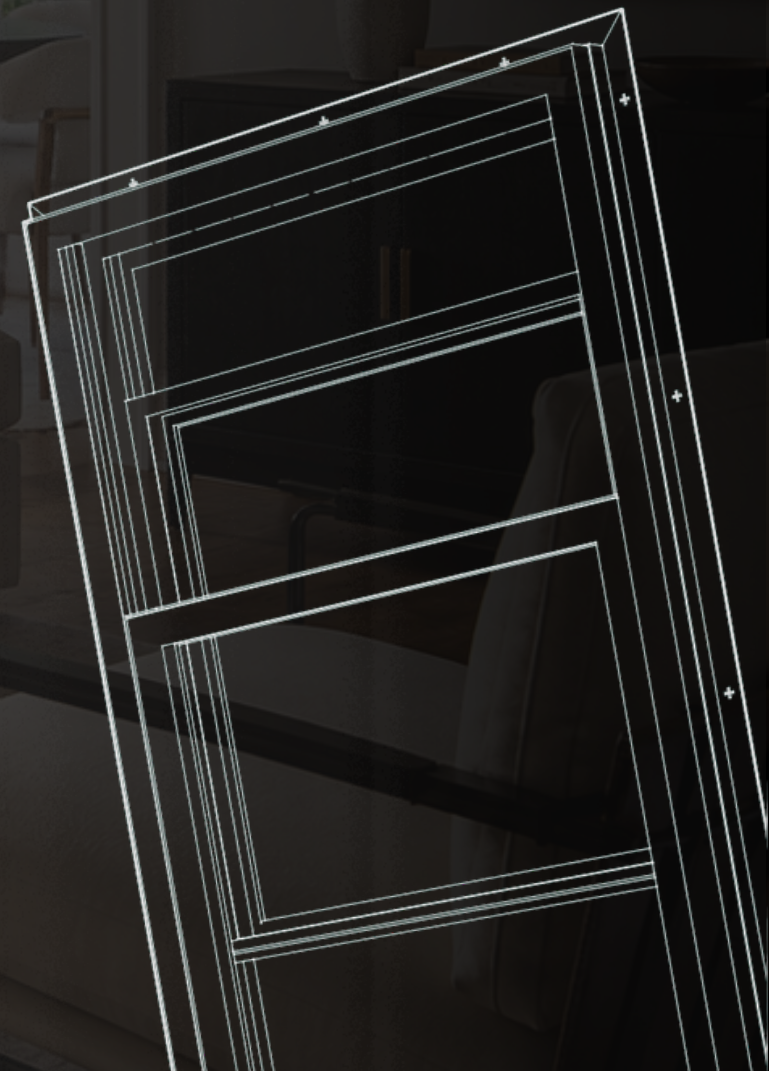

Avora Doors Profile Advantage



Thermal Insulation

Avora Doors uPVC windows and doors feature low thermal conductivity to help minimize energy loss. Designed with multi-chamber profiles, they effectively reduce heat transfer, enhancing insulation and overall energy efficiency.



Weather Resistance

Avora Doors uPVC profiles are built to withstand harsh elements—from UV exposure and heavy rain to extreme temperatures—while maintaining their color, shape, and long-term durability for years to come.



Sound Insulation

Avora Doors uPVC profiles feature a multi-chamber structure with tight seals that enhance sound insulation, helping create a quieter and more comfortable indoor environment.



Fire Resistance

Avora Doors uPVC materials used in windows and doors are difficult to ignite and do not support flame spread, helping enhance the overall fire safety of a building.



Strength & Safety

Avora Doors uPVC is a strong, durable material that can be reinforced with galvanized steel or aluminum inserts to enhance structural integrity—providing reliable performance and added security against forced entry.



Water Tightness

Avora Doors uPVC profiles are designed with gaskets and tight seals to ensure a secure fit, enhancing water tightness and protecting against rot, mold, and mildew for long-lasting performance.



AVORA DOORS

CONTENTS

03

Hung Window series

Classic vertical sliding windows for easy operation and timeless design.

07

Crank Window series

Smooth, crank-operated windows offering ventilation and secure sealing.

10

Window Drawings

Detailed technical drawings for accurate design reference and installation.

American
Style Windows



| Window Type

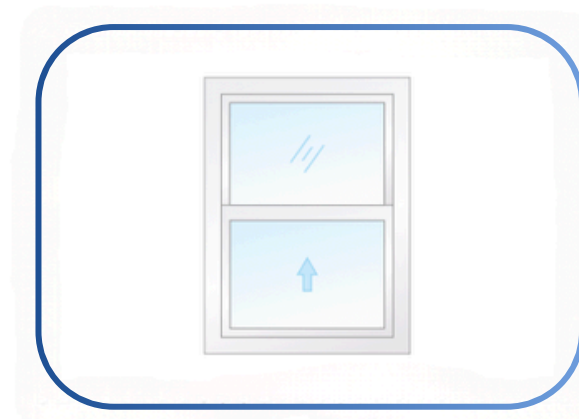

Single hung

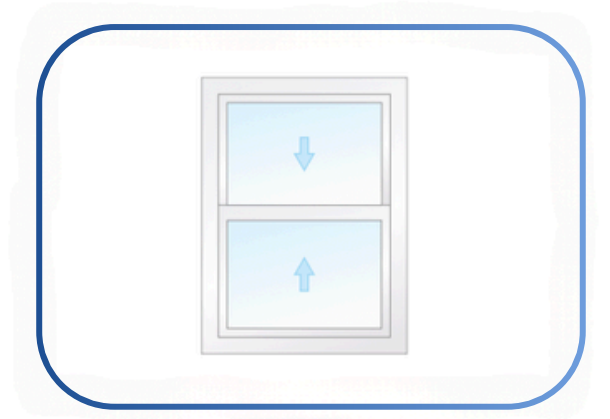

Double hung

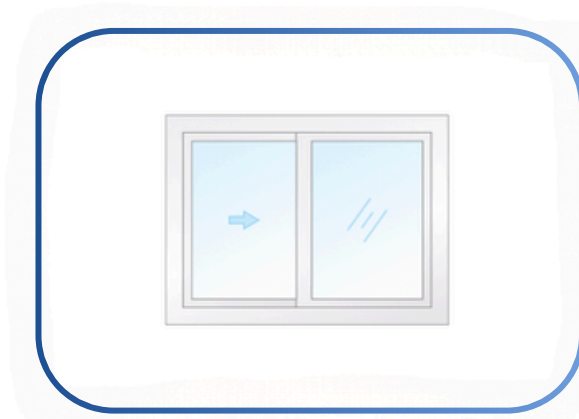

Single sliding

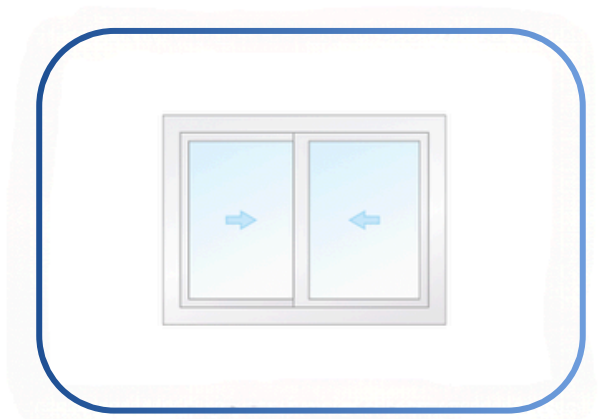

Double sliding



Fixed

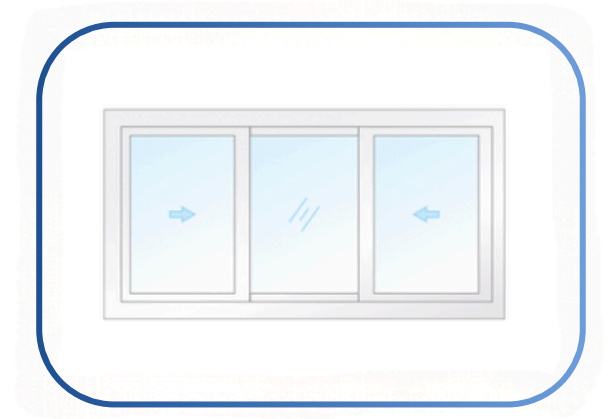

Three sash double sliding

Hung Window Series

Double Hung Window



AVORA DOORS



Double Hung Window

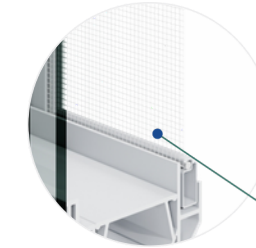

Screen

The metal-framed screen effectively prevents mosquitoes from entering when the window sash is opened. Springs are used on both sides for easy removal and cleaning.

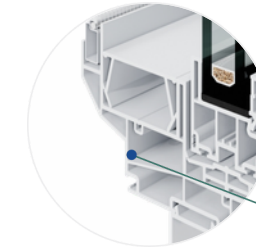

Drainage System

The interior is designed with drainage ribs and special equipment to create drainage holes, ensuring a stable and efficient drainage system.

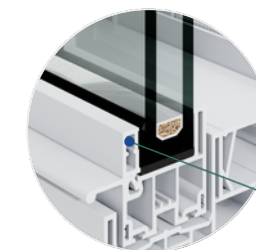

Design

The appearance has beautiful lines, clear edges and corners, noble and elegant appearance, and can be designed with various complex window shapes, providing owners and designers with a wider range of design space.



Glass Configuration

0.12 + 0.63A + 0.12 (in)
0.13 + 0.51A + 0.13 (in)



Size Range

20.08 in ≤ Width ≤ 43.31 in
32.28 in ≤ Height ≤ 74.80 in

Single Hung Window



Single Hung Window

Product Features

- Classic design offers a timeless look that suits a wide range of architectural styles.
- Sashes slide vertically within the frame, requiring no extra interior or exterior space.
- More affordable than double-hung and other complex window styles, making it a budget-friendly choice.
- A simple design with fewer mechanical parts reduces the risk of failure, ensuring durability and low maintenance.

Hung window Hardware

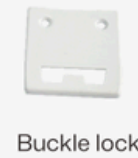
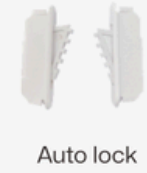
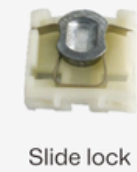

Glass Configuration

0.08 + 0.75A + 0.13 (in)
0.08 + 0.51A + 0.13 (in)



Size Range

18.90 in ≤ Width ≤ 43.31 in
31.89 in ≤ Height ≤ 74.80 in

Sliding Window



Product Feature

- Offers a sleek, contemporary look with large glass panes that provide unblocked views.
- The sliding mechanism is easy to operate and generally has fewer mechanical parts than more complex windows, leading to reliable performance.
- The panels do not swing open, they do not require any extra interior or exterior space to operate, making them ideal near patios, walkways, or furniture.

Single Sliding Window



Double Sliding Window



Glass Configuration

0.13 + 0.75A + 0.13 (in)
0.13 + 0.51A + 0.13 (in)

Sliding window Hardware



Crescent lock



Buckle lock



Size Range

Single Sliding

31.89 in ≤ Width ≤ 70.87 in
17.72 in ≤ Height ≤ 55.12 in

Double Sliding

32.68 in ≤ Width ≤ 70.87 in
19.29 in ≤ Height ≤ 55.12 in



Pull handle



Pulley

Crank Window Series

| Window Type

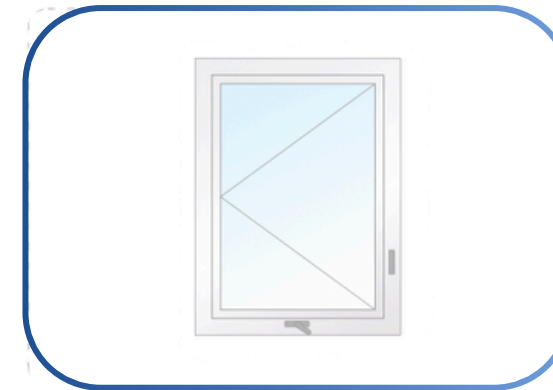

Crank window



Top hung

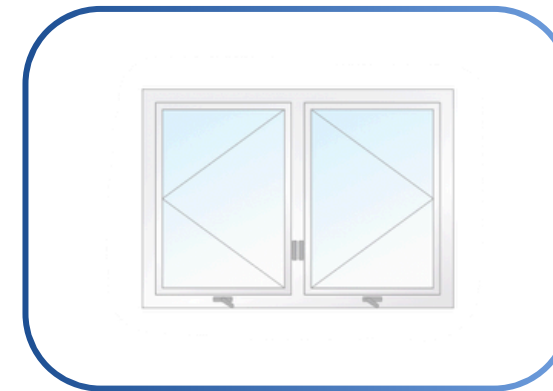

Double casement



Casement & fixed

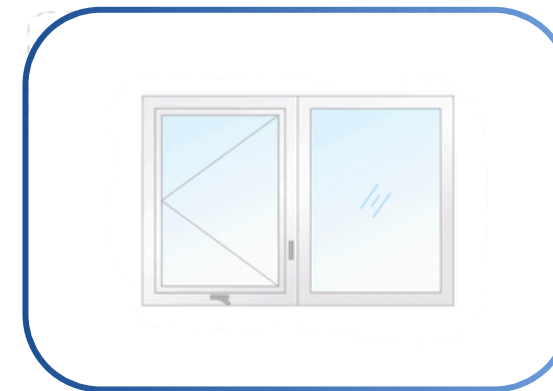

Splicing



Fixed

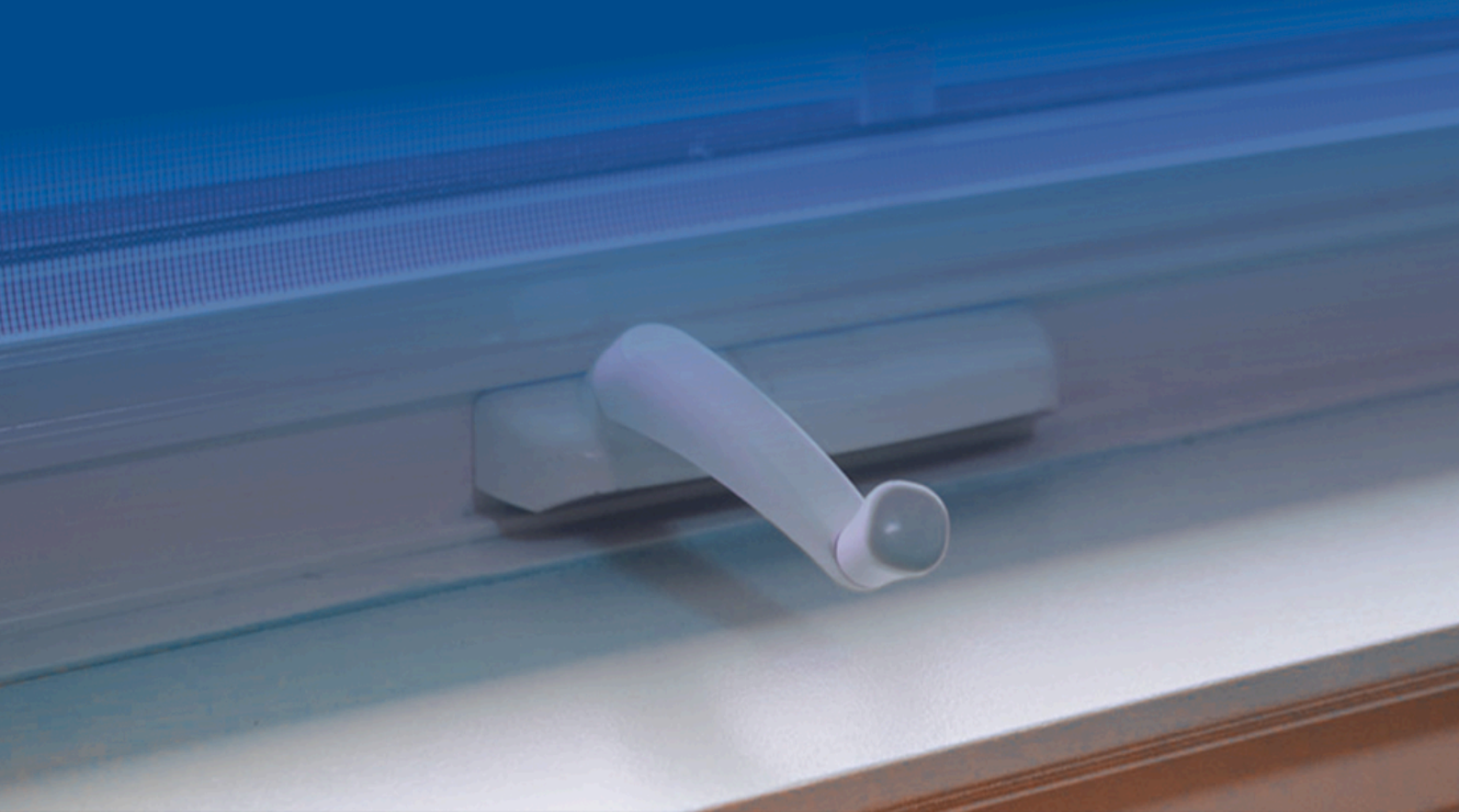

Crank Opening Window



Screen

The screens are located on the interior, keeping them from interfering with the operation of the window and protecting them from the elements to help them stay clean longer.



Operation

Crank window offers excellent energy efficiency, creates a very tight seal when closed, preventing drafts and reducing energy costs.

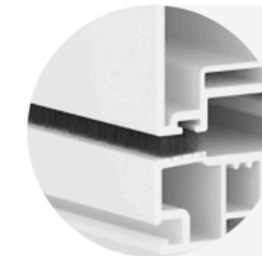

Brush Seal

Brush seals are used for sealing on the outdoor side to prevent the problem of excessive resistance caused by the rubber strips and improve the opening and closing feel.

Crank Opening Window



Glass Configuration

0.13 + 0.63A + 0.13 (in)
 0.13 + 0.75A + 0.13 (in)
 0.13 + 0.59A + 0.51A + 0.13 (in)
 0.13 + 0.51A + 0.13 + 0.51A + 0.13 (in)



Size Range (single casement)

Width ≤ 31.50 in
 Height ≤ 62.99 in

Crank window hardware



Crank handle



Hinge



Sash lock



Double Casement Window

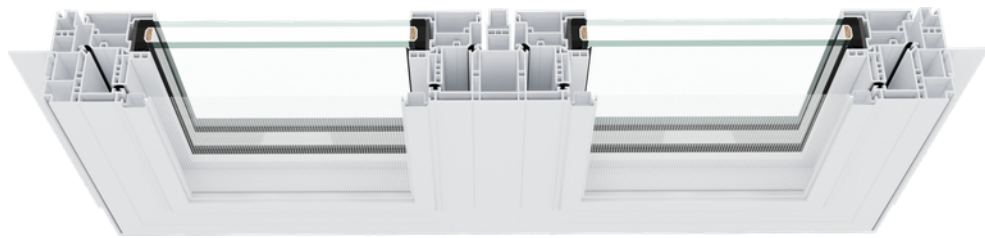

↖ ↗
↙ ↘

Size Range
Width ≤ 62.99 in
Height ≤ 62.99 in



Crank Opening Window

Splicing Window

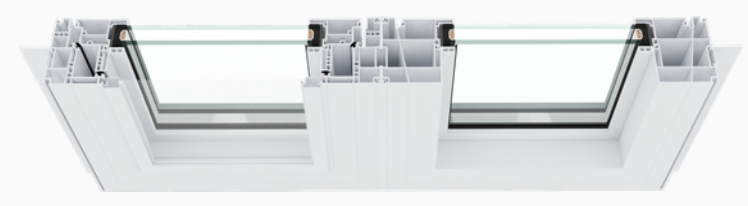

Fixed Window



Single Sash Range

Width ≤ 59.06 in
Height ≤ 59.06 in



AVORA DOORS

Hung Window Series Glazing Options

Window Drawings

Sash Glazing Bead

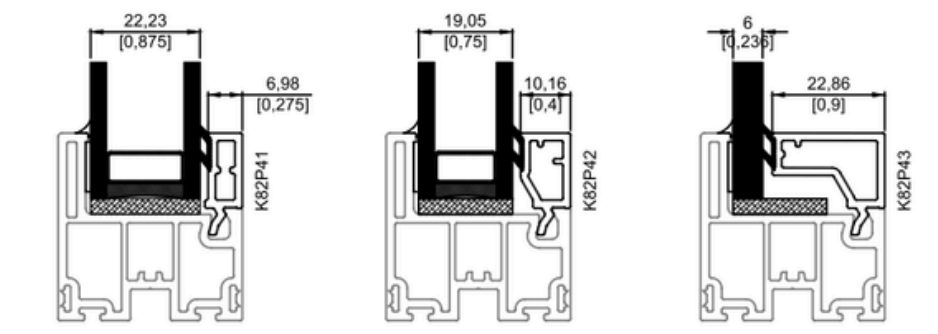

Frame Glazing Bead

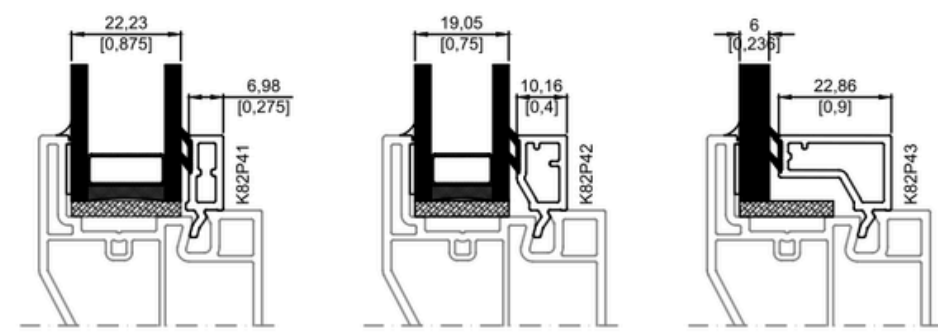

mm
[inch]

Single Hung Window

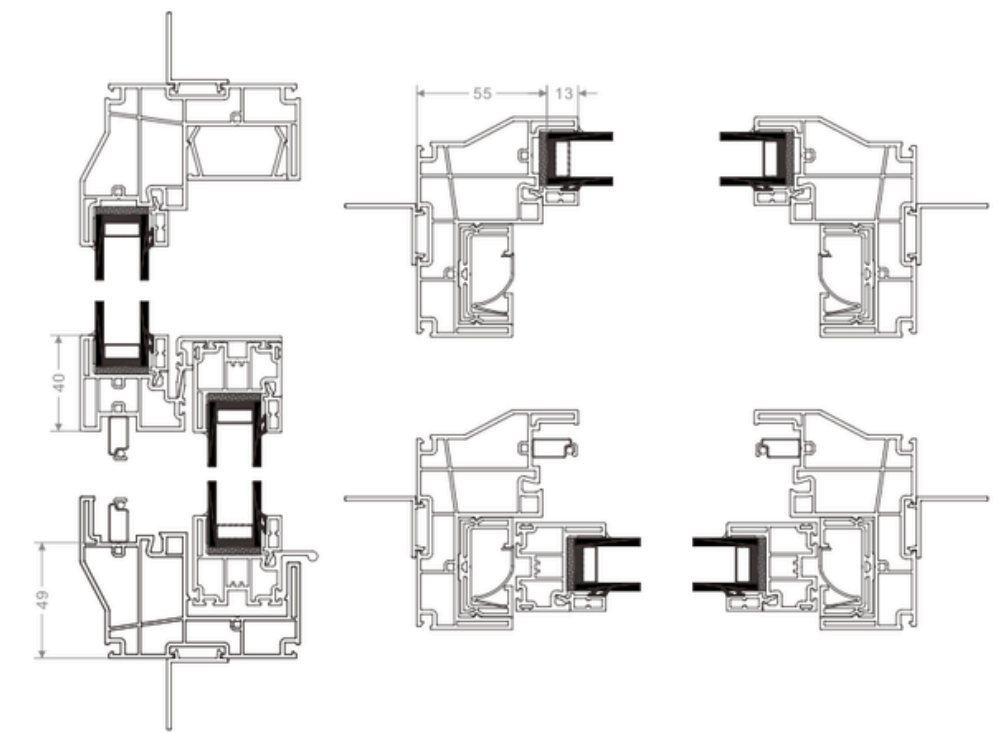

Vertical view

Horizontal view

Double Hung Window

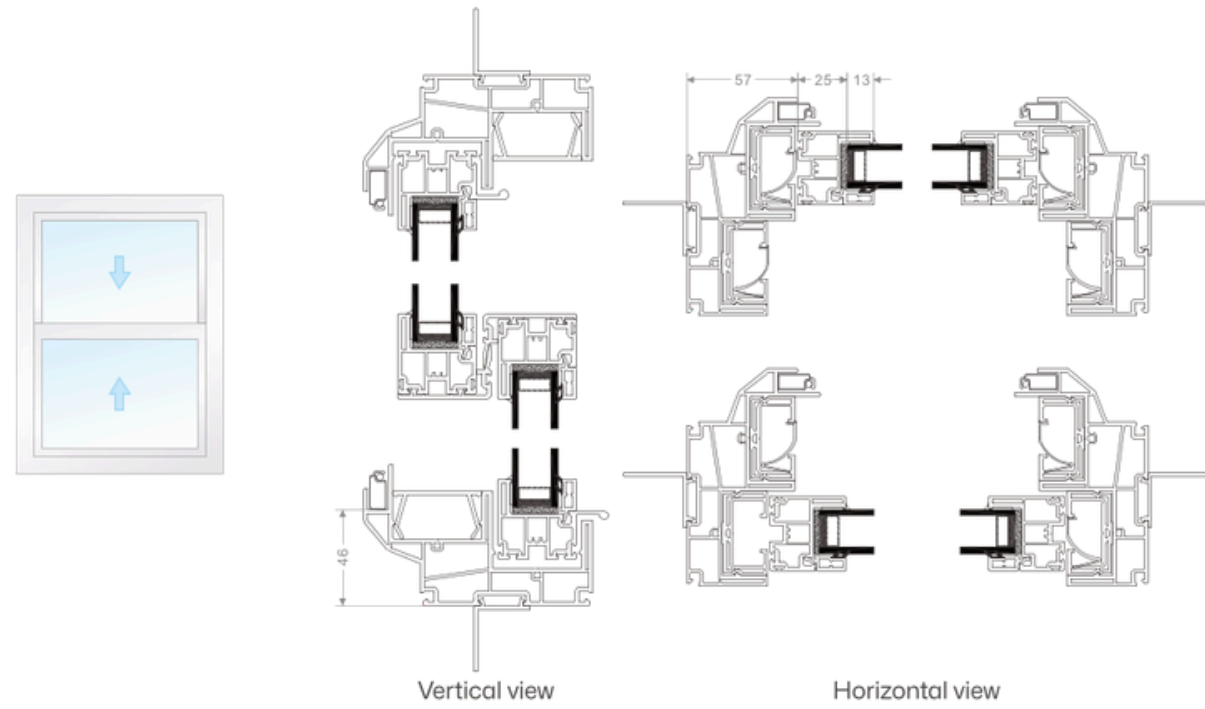

Double Sliding Window

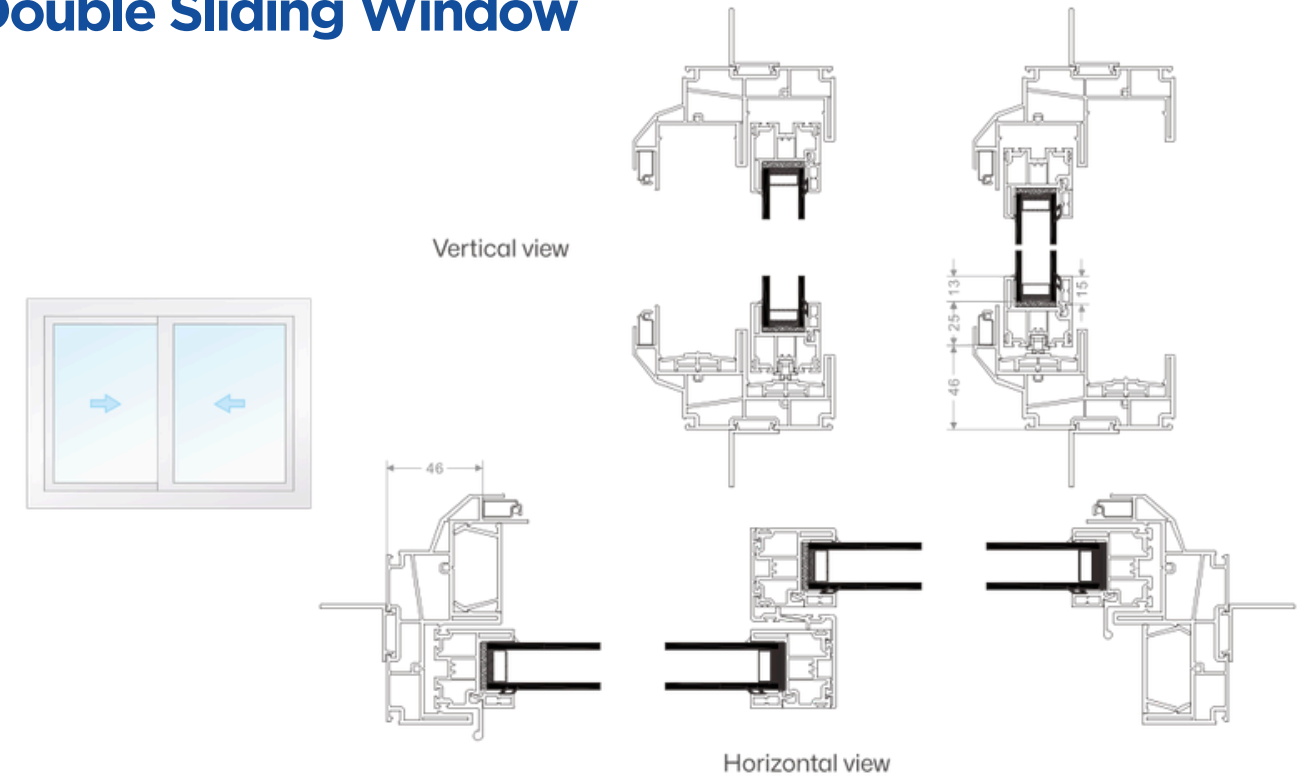

Single Sliding Window

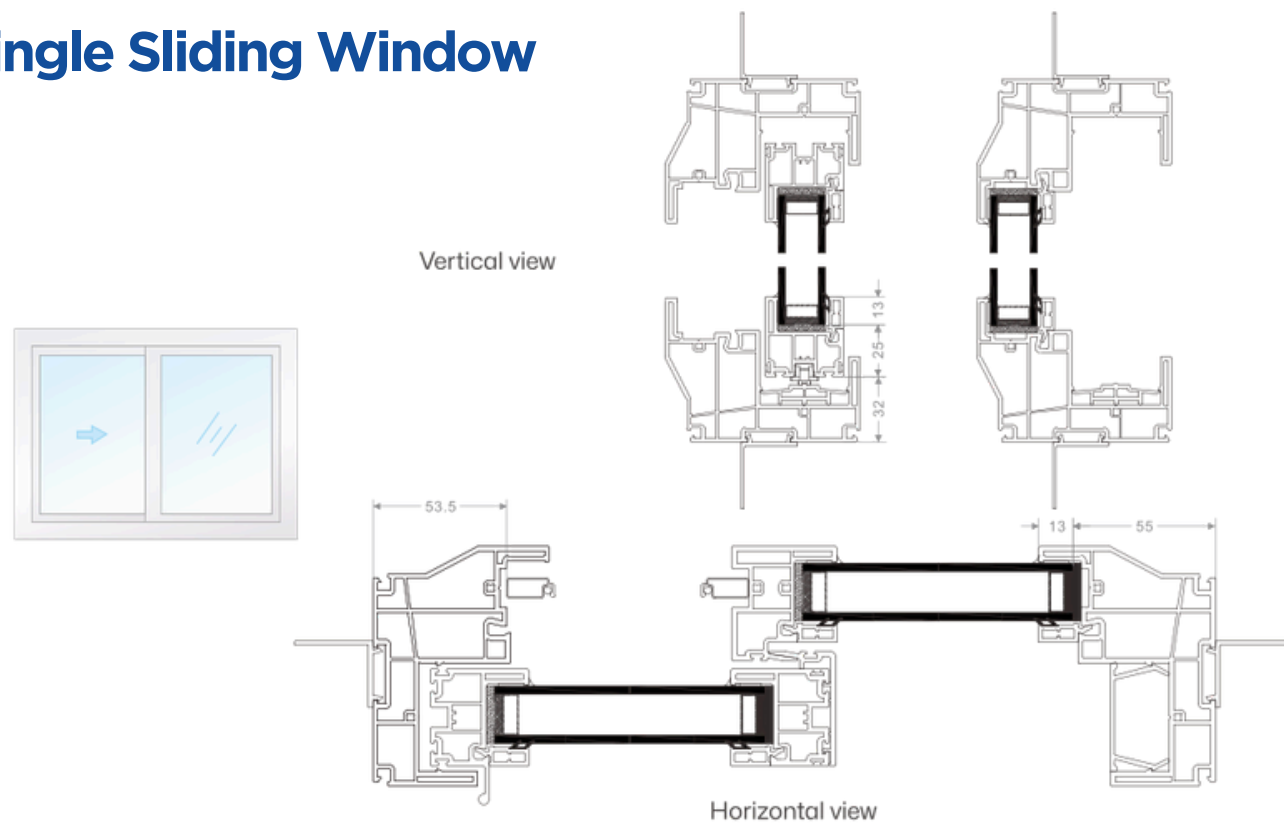

Crank Window Series Glazing Options

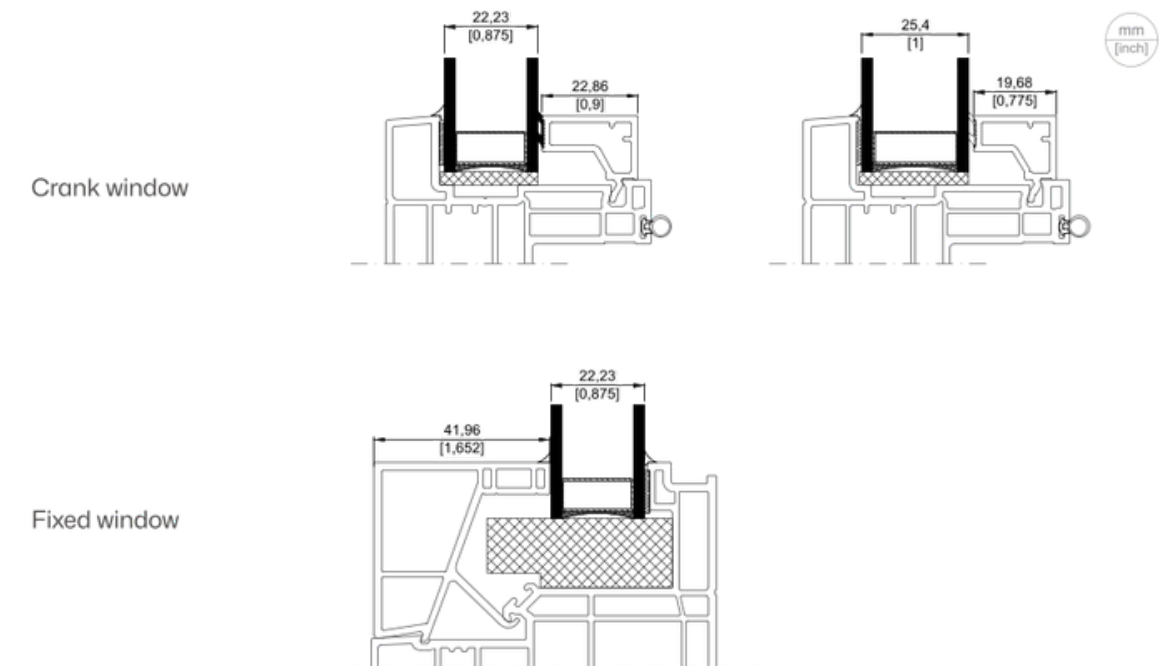

Crank Opening Window

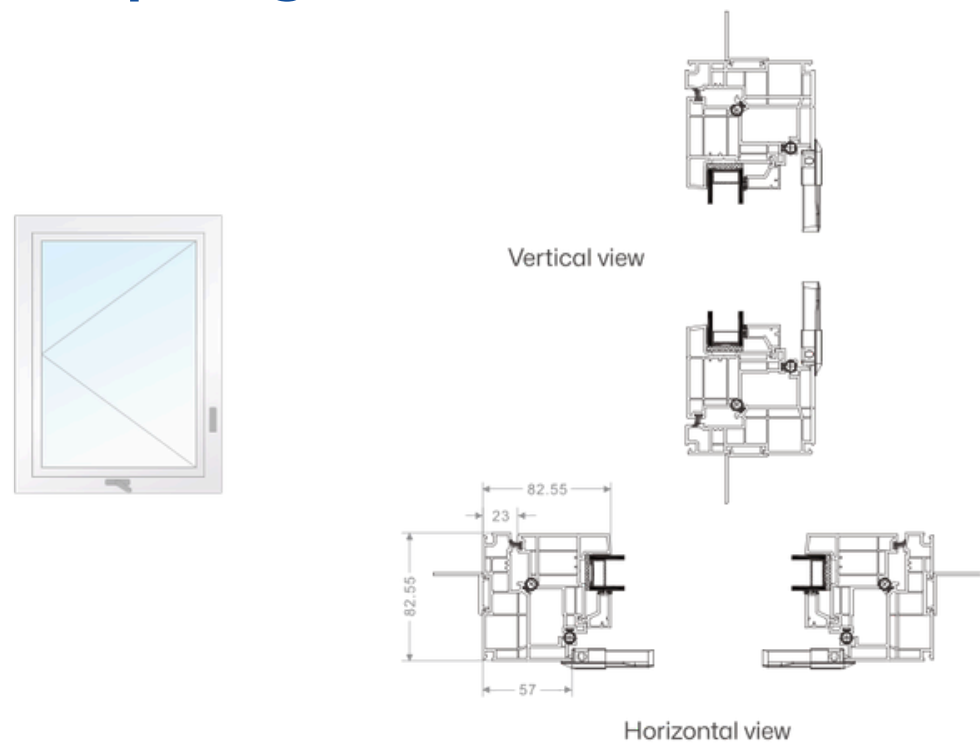

Two Sash Sliding Door

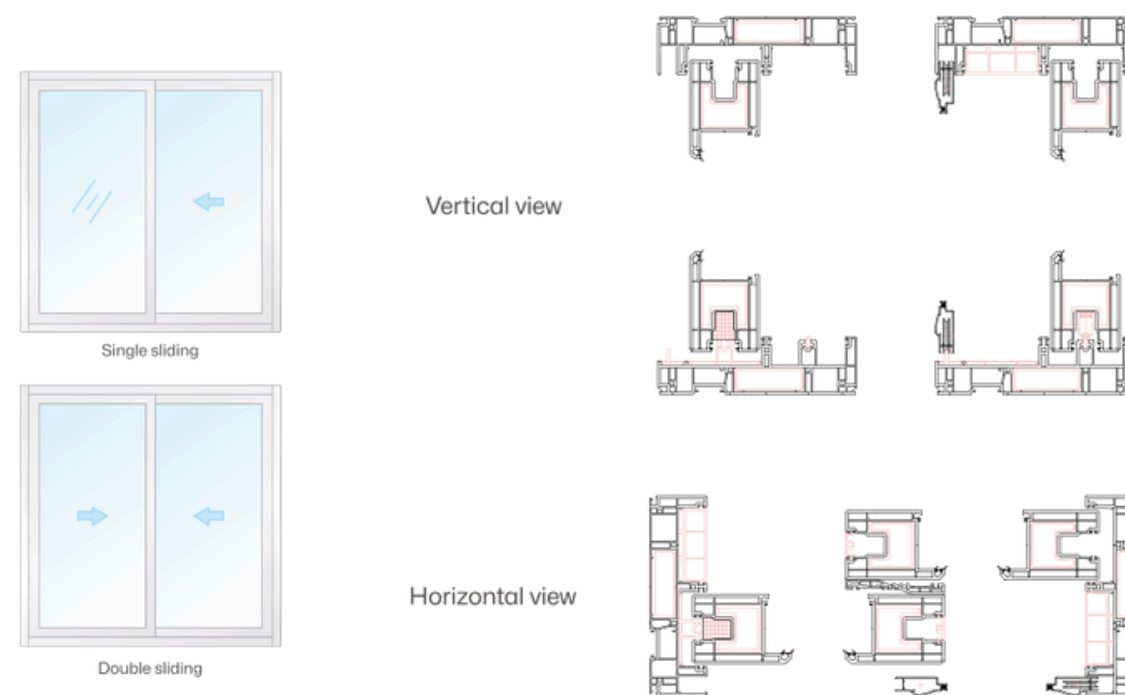

Casement and Fixed

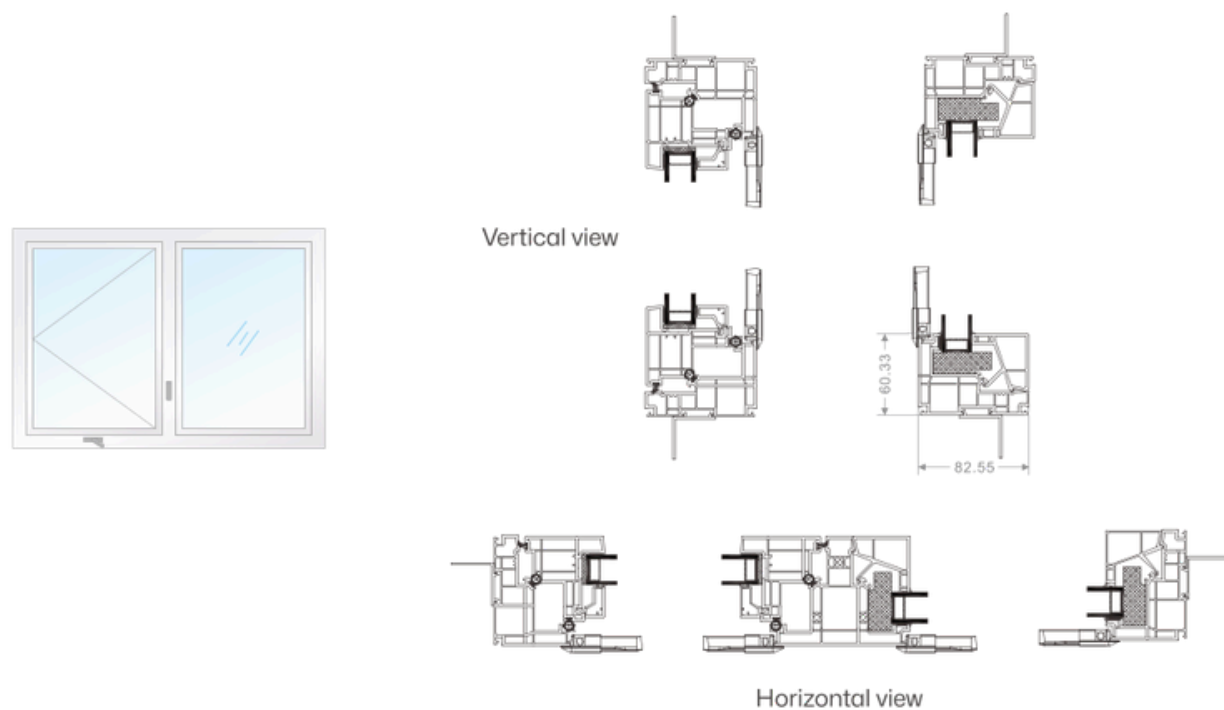

Three Sash Sliding Door

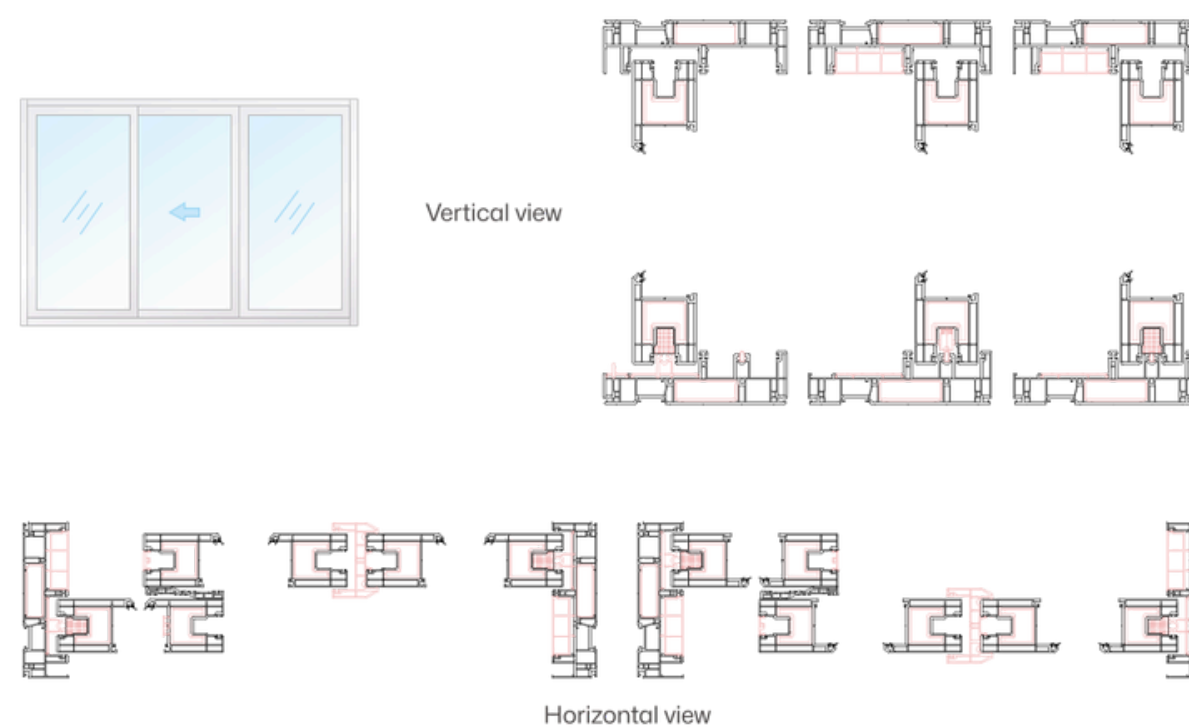

Hung Window Series

Three Sash Sliding Door

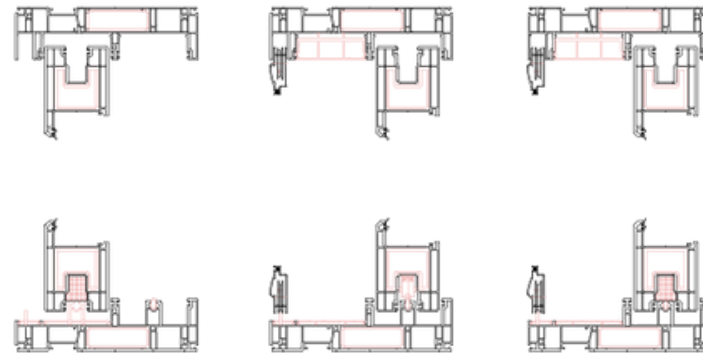

Vertical view

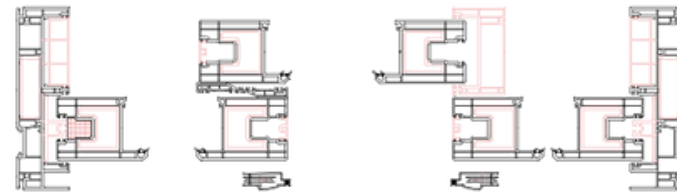

Horizontal view

Four Sash Sliding Door

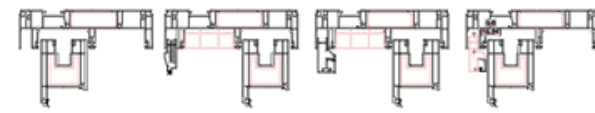
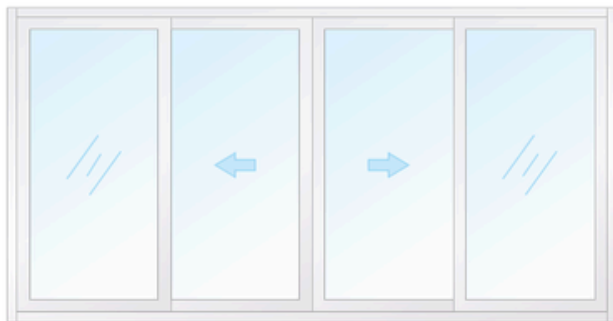

Vertical view

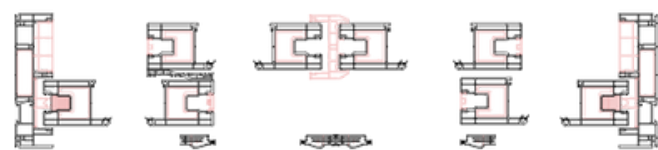
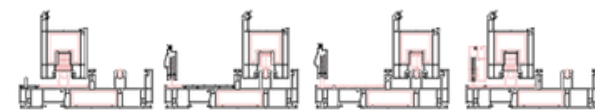

Horizontal view

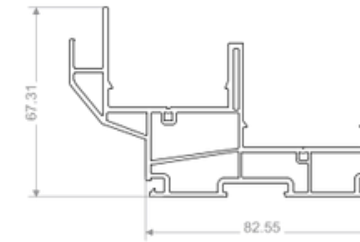

82 double sliding frame	CODE: 82STLCK
WEIGHT(KG/M): 1.38	PCS/BAG: 2

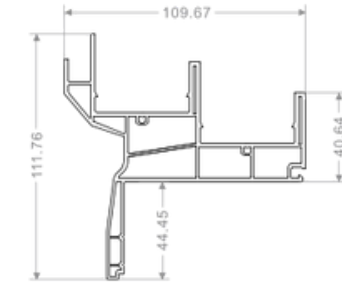

82 double hung F-frame 1	CODE: K82P15
WEIGHT(KG/M): 1.59	PCS/BAG:

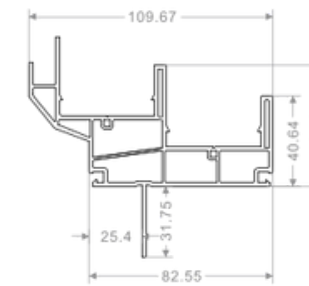

82 double hung F-frame 2	CODE: K82P16
WEIGHT(KG/M): 1.44	PCS/BAG:

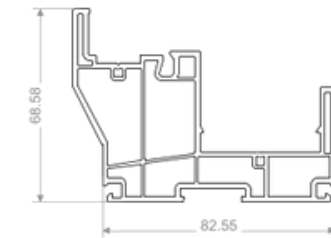

82 single sliding frame	CODE: 82DTLCK
WEIGHT(KG/M): 1.33	PCS/BAG: 4

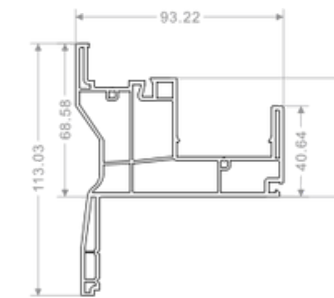

82 single hung F-frame 1	CODE: K82P17
WEIGHT(KG/M): 1.53	PCS/BAG:

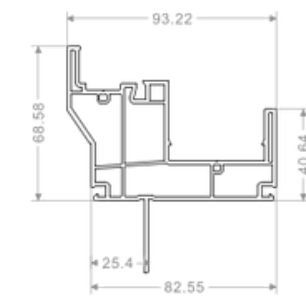

82 single hung F-frame 2	CODE: K82P18
WEIGHT(KG/M): 1.38	PCS/BAG: 4

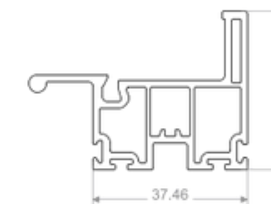

82 handle sliding sash	CODE: 82ZSS
WEIGHT(KG/M): 0.6	PCS/BAG: 6

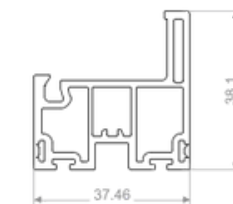

82 vertical sliding sash	CODE: 82TLS
WEIGHT(KG/M): 0.56	PCS/BAG: 6

Hung Window Series

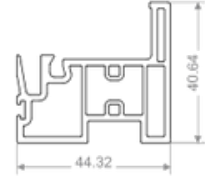

82 mullion	CODE: 82TLZT
WEIGHT(KG/M): 0.64	PCS/BAG: 6

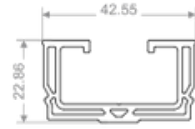

82 sliding groove	CODE: 82HXC
WEIGHT(KG/M): 0.43	PCS/BAG: 9

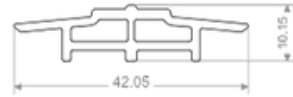

82 sash guide	CODE: 82DG
WEIGHT(KG/M): 0.203	PCS/BAG: 20

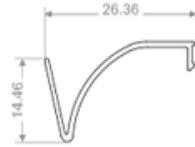

82 balancer cover	CODE: 82PHQGB
WEIGHT(KG/M): 0.067	PCS/BAG: 20

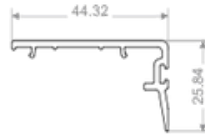

82 sliding sash cover	CODE: 82SFG
WEIGHT(KG/M): 0.217	PCS/BAG: 20

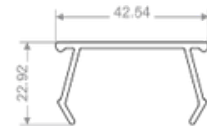

82 decoration cover	CODE: 82ZSGB
WEIGHT(KG/M): 0.22	PCS/BAG: 10

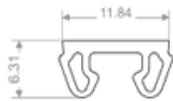

82 frame splicing strip	CODE: 82KPT
WEIGHT(KG/M): 0.052	PCS/BAG: 50

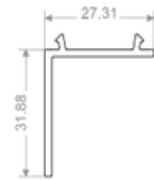

32 installation wing	CODE: 32AZY
WEIGHT(KG/M): 0.175	PCS/BAG: 20

Hung Window Series

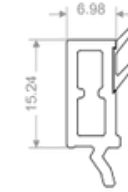

Glass thickness:
22.23 mm(0.875 inch)

7 glazing bead	CODE: K82P41
WEIGHT(KG/M): 0.145	PCS/BAG: 30

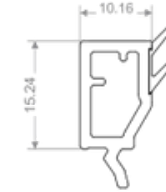

Glass thickness:
19.05 mm(0.75 inch)

10 glazing bead	CODE: K82P42
WEIGHT(KG/M): 0.155	PCS/BAG: 30

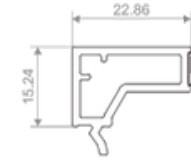

Glass thickness:
6 mm(0.236 inch)

23 glazing bead	CODE: K82P43
WEIGHT(KG/M): 0.2075	PCS/BAG: 20

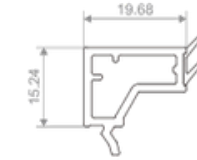

Glass thickness:
9.17 mm(0.361 inch)

20 glazing bead	CODE: K82P44
WEIGHT(KG/M): 0.19	PCS/BAG: 20

Crank Window Series

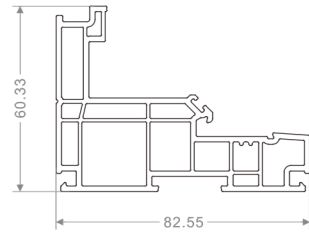

82 out-swing casement frame	CODE: K82P13
WEIGHT(KG/M): 1.15	PCS/BAG: 4

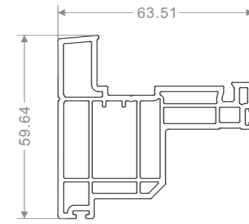

82 out-swing casement sash	CODE: K82P22
WEIGHT(KG/M): 0.96	PCS/BAG: 6

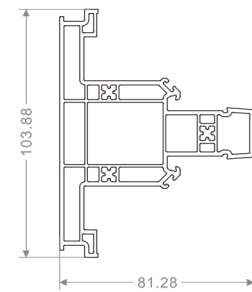

82 out-swing casement mullion	CODE: K82P32
WEIGHT(KG/M): 1.48	PCS/BAG: 2

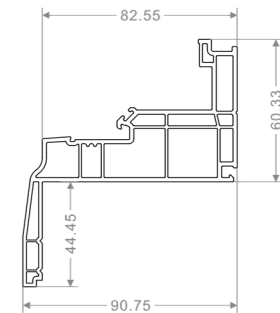

82 out-swing F-frame 1	CODE: K82P19
WEIGHT(KG/M): 1.34	PCS/BAG: 4

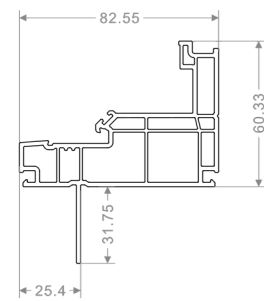

82 out-swing F-frame 2	CODE: K82P81
WEIGHT(KG/M): 1.19	PCS/BAG: 4

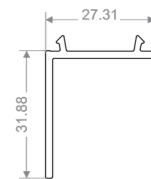

32 installation wing	CODE: 32AZY
WEIGHT(KG/M): 0.175	PCS/BAG: 20

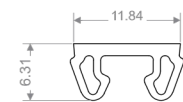

82 frame splicing strip	CODE: 82KPT
WEIGHT(KG/M): 0.052	PCS/BAG: 50

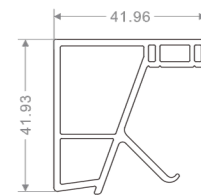

23 fixed glazing bead	CODE: K82P45
WEIGHT(KG/M): 0.56	PCS/BAG: 6

Glass thickness:
22.23 mm(0.875 inch)

Crank Window Series

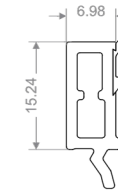

Glass thickness:
38.1 mm(1.5 inch)

7 glazing bead	CODE: K82P41
WEIGHT(KG/M): 0.145	PCS/BAG: 30

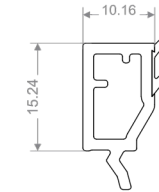

Glass thickness:
34.93 mm(1.375 inch)

10 glazing bead	CODE: K82P42
WEIGHT(KG/M): 0.155	PCS/BAG: 30

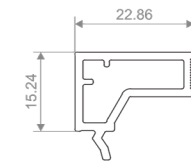

Glass thickness:
22.23 mm(0.875 inch)

23 glazing bead	CODE: K82P43
WEIGHT(KG/M): 0.2075	PCS/BAG: 20

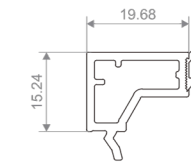

Glass thickness:
25.4 mm(1 inch)

20 glazing bead	CODE: K82P44
WEIGHT(KG/M): 0.19	PCS/BAG: 20

Sliding Patio Door Series

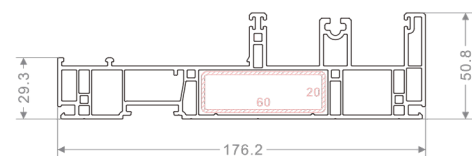

61 sliding door frame	CODE: K61T11
WEIGHT(KG/M): 2.3	PCS/BAG:

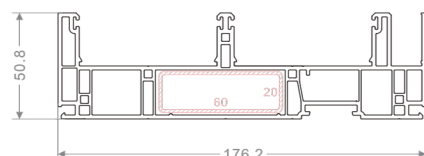

61 sliding door vertical frame	CODE: K61T12
WEIGHT(KG/M): 2.31	PCS/BAG:

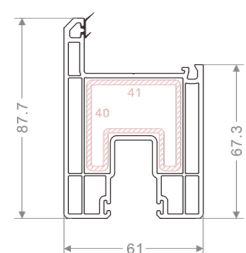

61 sliding door sash	CODE: K61T21
WEIGHT(KG/M): 1.43	PCS/BAG:

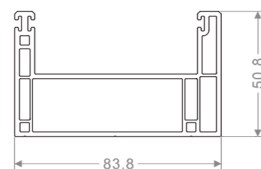

61 sliding door mullion	CODE: K61T31
WEIGHT(KG/M): 1.14	PCS/BAG:

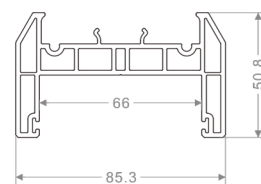

61 interlock	CODE: K61T61
WEIGHT(KG/M): 1.21	PCS/BAG:

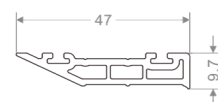

61 sash edge sealing	CODE: K61T62
WEIGHT(KG/M): 0.29	PCS/BAG:

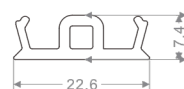

61 sash cover	CODE: K61T63
WEIGHT(KG/M): 0.12	PCS/BAG:

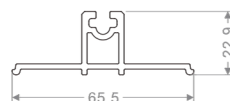

61 sliding door sash track	CODE: K61T64
WEIGHT(KG/M): 0.4	PCS/BAG:

Sliding Patio Door Series

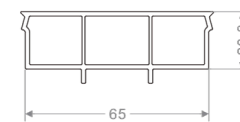

61 decoration cover	CODE: K61T65
WEIGHT(KG/M): 0.5	PCS/BAG:

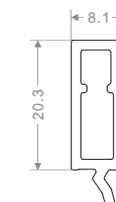

6108 glazing bead	CODE: K61T42
WEIGHT(KG/M): 0.18	PCS/BAG:

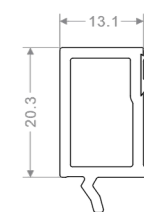

6113 glazing bead	CODE: K61T43
WEIGHT(KG/M): 0.21	PCS/BAG:

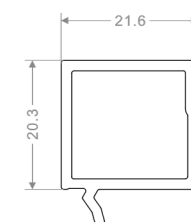

6122 glazing bead	CODE: K61T44
WEIGHT(KG/M): 0.24	PCS/BAG:

*The weight of the sliding door profile is theoretical weight.